

access

LIGHTING

INSTALLATION INSTRUCTIONS

IMPORTANT SAFETY INSTRUCTIONS

MESURES DE SECURITE A RESPECTURE

Before assembling your ACCESS LIGHTING fixture, please make sure that you carefully read through this instruction sheet. Save this instruction sheet and refer to it when additions to or changes in the fixture configuration are made.

Lisez attentivement ce manuel d'instructions. Enregistrer cette feuille d'instructions et de s'y référer lorsque les ajouts ou changements dans la configuration de montage sont faites.

CONSULT A QUALIFIED ELECTRICIAN TO ENSURE CORRECT BRANCH CIRCUIT CONDUCTOR.

CONSULTEZ UN ELECTRICIEN QUALIFIE POUR VOUS ASSURER QUE LES CONDUCTEURS DE LA DERIVATION SONT ADEQUATS

THIS PRODUCT MUST BE INSTALLED IN ACCORDANCE WITH THE APPLICABLE INSTALLATION CODE BY A PERSON FAMILIAR WITH THE CONSTRUCTION AND OPERATION OF THE PRODUCT AND THE HAZARDS INVOLVED.

CE PRODUIT DOIT ETRE INSTALLE SELON LE CODE D'INSTALLATION PERTINENT, PAR UNE PERSONNE QUI CONNAIT BIEN LE PRODUIT ET SON FONCTIONNEMENT AINSI QUE LES RISQUES INHERENTS

NOTE: The important safeguards and instructions that appear in this manual are not meant to cover all possible conditions and situations that may occur. It must be understood that common sense, caution and care, are factors that can't be built into any product. These factors must be supplied by the person(s) caring for and operating the fixture.

Read all instructions

Do not install this fixture in hazardous locations.

N'installez pas cet appareil dans des emplacements dangereux.

Do not install any fixture assembly closer than 6 inches from any curtain or similar combustible material.

Laissez une distance d'au moins 6 pouces entre ce luminaire et la toute surface combustible.

"WARNING Risk of Fire and Electric Shock."

"CAUTION: Risque d' Incendie et de Choc Electriques."

GENERAL INFORMATION

All electrical connections must be in accordance with all ordinances, Local and the U.S. National Electrical Codes (NEC). These fixtures are intended for mounting to a standard 4" metal octagon outlet box.

The box must be directly supported by the building structure and U.L. Recognized.

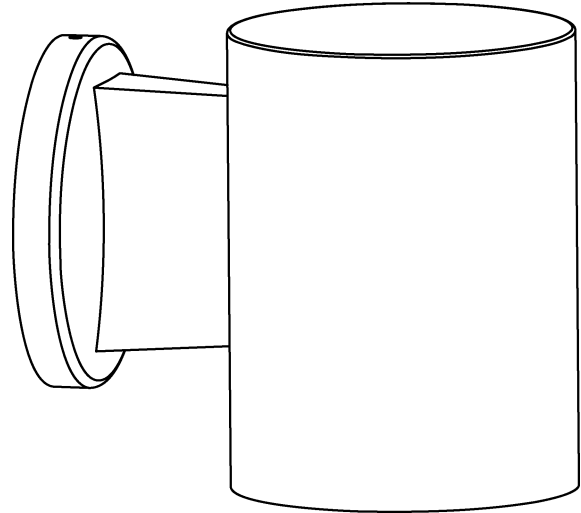

COLLECTION
Poseidon

APPLICATION
Wall Fixture

MODEL NO.
20363LEDDL

WHAT WE PROVIDE

- Crossbar
- Fixture Assembly
- Mounting Hardware
- 1 X A19 E-26 LED Bulbs

WHAT YOU NEED

- Screwdriver
- Wire Cutters
- Wiring Supplies as Specified by Electrical Code

Recommended Dimmers for Supplied Bulb

(ELV) LUTRON Skylark SELV-300P
(MLV) COOPER Aspire 9530SW
(TRIAC) LEGRAND Titan CD703-PW

STEP BY STEP INSTRUCTIONS

Before starting your installation disconnect the Power by turning off the Circuit Breaker or by removing the fuse at the fuse box. Just turning the light off at the light switch is not sufficient to prevent electrical shock.

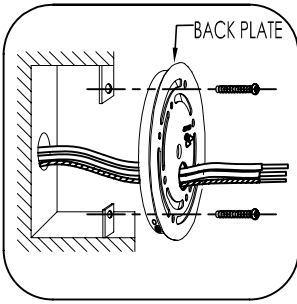

1

PREPARE THE FIXTURE

If you are replacing an existing fixture, disconnect and remove the old fixture.

Expose the supply wiring from the j-box and pass the wire through the designated hole on the back plate.

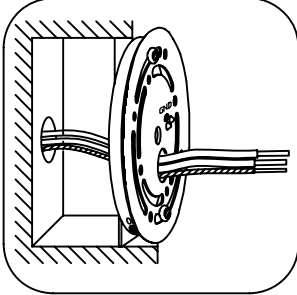

2

MOUNT THE BACK PLATE

Use the two supplied long screws to mount the back plate to the J-box.

Ensure that the small hole located on the edge of the back plate faces down or south, thus allowing potential water to drain downwards.

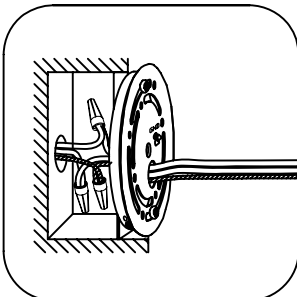

3

CONNECT THE WIRES

Gently pull the supply wires. Connect the black fixture wire to the black supply wire and the white fixture wire to the white supply wire.

Connect the fixture ground wire to the ground wire from the J-Box.

Secure all connections with the supplied wire connectors and U.L listed electrical tape (not supplied). Tuck all wires carefully into the J-Box.

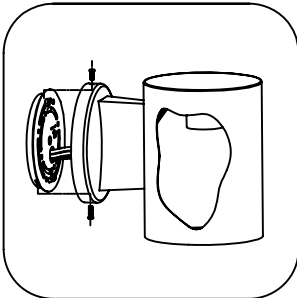

4

MOUNT THE FIXTURE

Place the fixture canopy over the back plate such that the fixture is flush against the wall. Secure with the supplied short screws.

NOTE: This fixture has been Certified, For Wet Location, and is for outside application. Therefore to reduce the risk of electrical shock it is strongly recommended that a silicone caulking be utilized to provide a watertight seal between the fixture and its mounting surface.

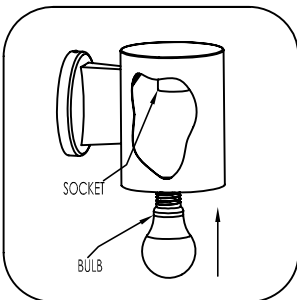

5

INSERT THE BULB

DO NOT EXCEED THE MAXIMUM WATTAGE AS STATED ON THE WARNING LABEL

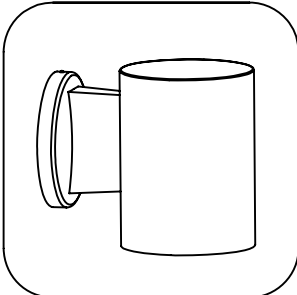

6

RESTORE THE ELECTRICITY AND CHECK THE

OPERATION OF YOUR NEW ACCESS LIGHTING FIXTURE

