

INSTALLATION NOTES

WR 484 * FW 484

BATHING MODULES

Door Opening 45 3/8" Wide X 74 1/2" High



INSTALLATION NOTES

1. Inspect framed-in area for proper size, level, square, and plumb.
2. Position module in framed pocket. Check to be sure that module is plumb and level. Be sure apron is down tight to the floor and module walls are touching studs of framed area.
3. Spot nail through the nailing flanges at the lower front corners.
4. Continue to nail, approximately 8 inches on center starting from the bottom and working to the top of the side wall nailing flanges. Nail the top flanges to each stud.
5. Starting from the finished side, drill or hole-saw plumbing hardware holes. Double check hole locations prior to drilling.
6. After installation, clean module with warm water and liquid detergent. Paints and other materials can be easily removed without damage to the unit by the use of turpentine, paint thinner, or acetone.
7. Any scratches or dull areas in unit may be removed with automotive type rubbing compound.

INSTALLING OPTIONAL TOP

- A. Place top on unit.
- B. Make sure the face of the top and tub are flush and nailing flanges of top and tub are in line.
- C. Drill 1/4 inch holes in corners.
- D. Fasten with 1/4 x 1 inch bolts, flat washer on each side.
- E. No caulking or gasket necessary between top and tub.

NOTE
ALL DIMENSIONS
MAY VARY
± 1/4"

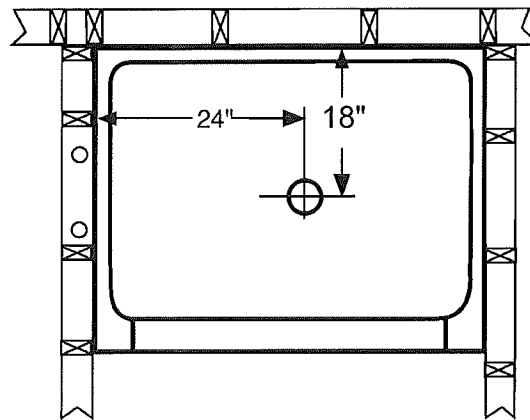
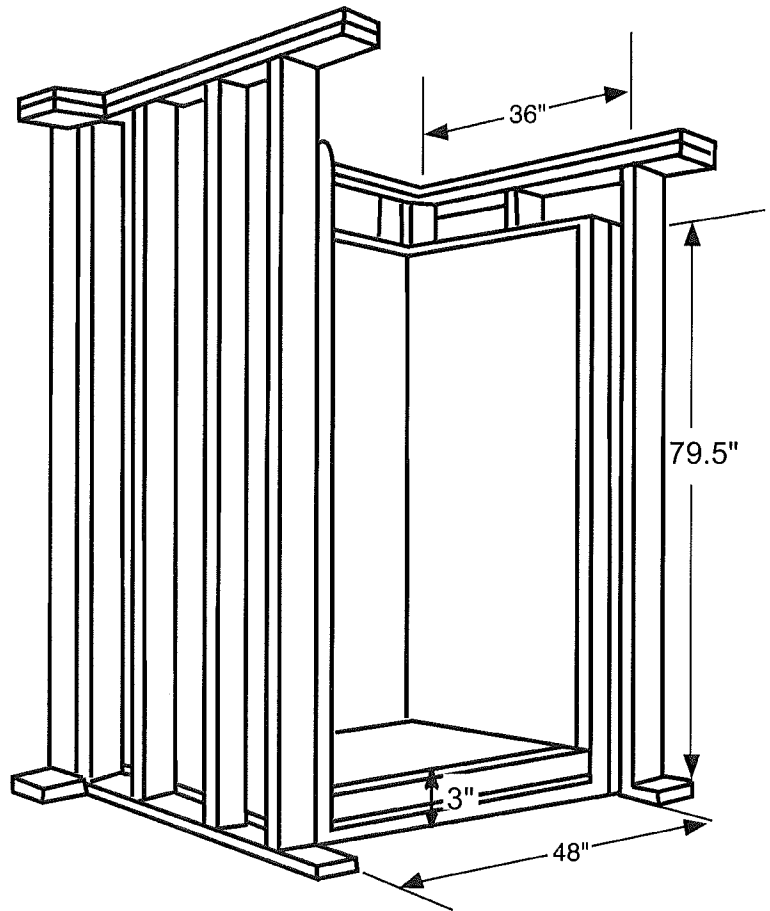

WARM RAIN

P.O. Box 600 • 51675 N. Industrial Drive • Hancock, MI 49930

Voice: 906-482-3750 • Fax: 906-482-2585 • Email: tedk@warmrain.com • www.warmrain.com